



aerospace
 climate control
 electromechanical
filtration
 fluid & gas handling
 hydraulics
 pneumatics
 process control
 sealing & shielding



Fuel Filtration Systems

Products and Custom Solutions



ENGINEERING YOUR SUCCESS.

About Racor

Parker Hannifin Corporation, global leader in motion and control technologies, delivers an unmatched breadth of engineered products and solutions. Our commitment to our customers is backed by the strength that comes from over 90 years of knowledge and experience.

About Racor.

For over forty years Parker's Racor Division has been one brand of fuel filtration systems that has earned the confidence and respect of engine and equipment builders, owners and operators around the world.

Leading edge technology and continuous innovation are designed into every system, and genuine Aquabloc® filters have set the global standard.

In every configuration, at every flow rate, and in any operating environment, Racor is the most trusted name in engine protection. Why trust your investment to anything less?



A World of Fuel Challenges

Fuel contamination, either in the form of dirt or water, will find its way into your fuel system however careful you are. With modern engines now injecting fuel at pressures up to 30,000 PSI, and injector tolerance being measured in microns, even a small amount of dirt or water corrosion can start problems. Water or particulates can cause microscopic surface damage that is then focused on by the high-pressure fuel flow, which causes wear that will eventually lead to reduced efficiency and complete breakdown. With this in mind, managing fuel delivery and system cleanliness through proper filtration becomes an absolute imperative for economical engine operation.



For marine applications, please see Racor brochure #7501.

Racor Solutions For Your Future

Racor has quality-certified manufacturing, engineering and distribution in place around the world, so no matter where you are you can rely on Racor to solve tough filtration problems from the refinery to the engine. Over the years, Racor has kept pace with the increasing demands of fuel filtration, from tough engine requirements for ever-finer particle-removal efficiencies and longer life, to the effective processing of ULSD and biodiesel.

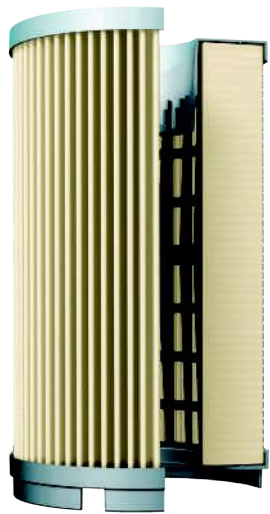

The heart of these advances is in Racor's proprietary engineered filter media families. Our selection of Aquabloc® medias is known worldwide for its combination of high efficiency, long life and unsurpassed water-removal performance, meeting and exceeding the challenges of today's diesel engine requirements in all markets and environments.

Using Aquabloc® media, Racor Engineering develops innovative solutions to become integral components in complex engine fuel systems designed by the world's leading OEM engine manufacturers. Racor develops new solutions using ISO, SAE, JIS and other world-recognized testing procedures to conform to any specifications required by our OEM customers. Racor performs on-engine, on-vehicle and laboratory diesel system testing to further the advancement of diesel filtration for today and into the future. All diesel engine users benefit from this ongoing demand for the latest technology in fuel filtration and fuel system designs.

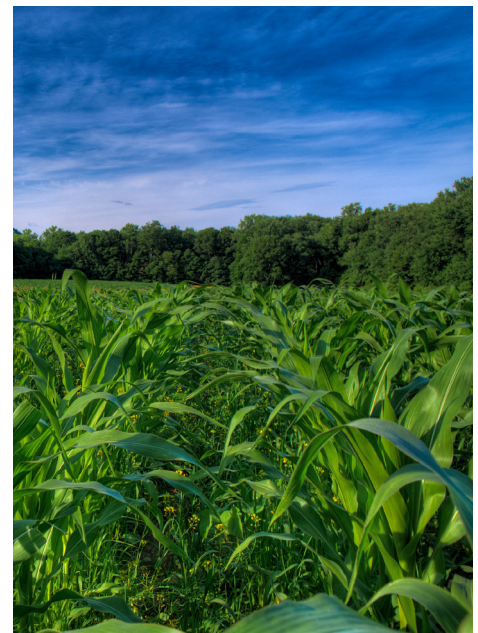

The future of the diesel engine relies on increasingly stringent exhaust emission requirements, while the quality of diesel fuel continues on a worldwide decline. New diesel engines require extraordinary fuel cleanliness and freedom from water contamination to meet these requirements. Ultra low sulfur diesel (ULSD) and the rapidly expanding use of biodiesel pose new filtration challenges due to their tendency to dissolve existing deposits, absorb water, and support the growth of bacteria. Even cold weather operation is compromised by the new fuels, leading to downtime and problems on an increasing frequency.



Cost-Effective Visual Inspection

See-thru collection bowls allow a water-in-fuel condition to be immediately visible.

Environmentally Friendly

Engineered polymer bowls are reusable, impact-resistant and virtually indestructible. When it's time for service, only the filter element is replaced - the see-thru bowl and drain valve assembly are reused. The long life cycle of the bowl saves money and reduces the environmental impact through disposal of less material.

Easy Upgrades

See-thru bowls provide connection ports for upgrades that enhance engine performance and reliability. Powerful in-bowl heaters can be added to improve operation in colder climates and electronic sensors alert the operator to drain water in the bowl.

Corrosion-Free Construction

Advanced polymer technology means bowls will not deteriorate from water collection, alcohol-blended fuels, exposure to harsh additives or UV light.

High quality gaskets and O-rings for consistent, sure seals.

Die cast aluminum mounting heads with multiple ports make installation as easy as adding options.

Durable hand primer pumps are integrated into mounting heads.

The heart of every Racor filter is the engineered filter media. Aquabloc II® is known around the world for its combination of high efficiency, long life and unsurpassed water-removal performance.

Polymer bowls are highly durable. They won't discolor from exposure to alcohol, additives or UV light - a see-thru that stays see-thru. A die cast aluminum bowl is available for most models.

Water sensor and vacuum gauges to signal service are valuable options available for most models.

Positive seal self-venting drain eliminates leaks and expedites service.





Model 460R

445 - 460 - 490

A powerful, integral primer pump makes service quick and easy

The standard equipment primer pump tops the list of extensive options that allow bus fleets, truck fleets, RV owners and others to tailor a filter/separator system specifically to their operating requirements. These options include a choice of a three-micron rating for the Aquabloc® filter element, 200-watt in-bowl resistance heater, water sensor and flow rates up to 120 gph.



Model 660R

645 - 660 - 690

Maximize engine protection with a low-profile, easy-to-fit filtration system

With all the features of the 400 Series, the 600 Series offers engine owners an economical system for applications where an integral primer pump is not needed. Flow rates up to 120 gph, in-bowl heater and water sensor are all available options.



MEDIUM FLOW

MODEL	445	460	490	645	660	690
Maximum Flow Rate	45 gph / 170 lph	60 gph / 227 lph	90 gph / 341 lph	45 gph / 170 lph	60 gph / 227 lph	90 gph / 341 lph
Gasoline or Diesel	Diesel	Diesel	Diesel	Both	Both	Both
Vacuum Installation	Yes	Yes	Yes	Yes	Yes	Yes
Pressure Installation	Yes	Yes	Yes	Yes	Yes	Yes
Maximum PSI / kPa	30 psi / 207 kPa	30 psi / 207 kPa	30 psi / 207 kPa	30 psi / 207 kPa	30 psi / 207 kPa	30 psi / 207 kPa
Clean Pressure	0.17 psi	0.39 psi	0.95 psi	0.01 psi	0.05 psi	0.29 psi
Drop PSI / kPa	1.2 kPa	2.7 kPa	6.5 kPa	0.07 kPa	0.34 kPa	2.0 kPa
No. of Ports	4	4	4	7	7	7
Port Size	3/8" NPT / 16 mm	3/8" NPT / 16 mm	3/8" NPT / 16 mm	3/8" NPT / 16 mm	3/8" NPT / 16 mm	3/8" NPT / 16 mm
Integral Primer Pump ²	Yes	Yes	Yes	No	No	No
Replacement Element No. ³	R45	R60	R90	R45	R60	R90
Bowl / See-Thru	Yes	Yes	Yes	Yes	Yes	Yes
Bowl / Metal	No	No	No	No	No	No
Drain Type	Self-Vent	Self-Vent	Self-Vent	Self-Vent	Self-Vent	Self-Vent
Water Sensor Option ⁴	Yes	Yes	Yes	Yes	Yes	Yes
Electric Heater Option ⁴ (12V/24V)	Yes	Yes	Yes	Yes	Yes	Yes
Height	9.3 / 236 mm	11 / 279 mm	11.8 / 300 mm	8.46 / 215 mm	10.2 / 259 mm	11.2 / 284 mm
Width	4.5 / 114 mm	4.5 / 114 mm	4.5 / 114 mm	4.5 / 114 mm	4.5 / 114 mm	4.5 / 114 mm
Depth	4.8 / 121 mm	4.8 / 121 mm	4.8 / 121 mm	4.5 / 114 mm	4.5 / 114 mm	4.5 / 114 mm
Weight	2.5 lbs / 1.1 Kg	2.7 lbs / 1.3 Kg	2.9 lbs / 1.4 Kg	2.35 lbs / 1.07 Kg	2.58 lbs / 1.17 Kg	2.65 lbs / 1.2 Kg

Notes:

- (1) Pressure installations are applicable up to the maximum PSI/ kPa shown.
- (2) Models with integral primer pumps are not recommended for gasoline applications.
- (3) Replacement element micron rating can be specified as "S" for 2 micron, "T" for 10 micron, or "P" for 30 micron.
- (4) Not for use with gasoline applications.

110A - 120A - 140

Maximum protection in minimum space

The 110A is designed for fuel-injected gasoline engines with high working pressures and also can be used on diesel engines. A metal housing is standard. Other models in the 100 Series, the 120A and 140, offer reliable protection for smaller diesel and gasoline engines used in generator sets, pressure washers and other equipment. Their compact size fits tight mounting locations and multiple ports offer installation flexibility.



Model 120AT

215 - 230 - 245

Improved for greater versatility

The 215, 230 and 245 filter/separators come standard with an integral priming pump and a new see-thru contaminant bowl, which can operate in applications up to 30 psi. Another design upgrade is the optional 200-watt in-bowl heater for colder operating conditions. Applications include light-duty and medium-duty trucks and vehicles, construction, agricultural and other diesel-powered equipment.



Model 230R2

For marine rated filters, see brochure #7501.



LOW FLOW

MODEL	110A	120A	140	215	230	245
Maximum Flow Rate	15 gph / 57 lph Diesel 35 gph / 132 lph Gas	15 gph / 57 lph	15 gph / 57 lph	15 gph / 57 lph	30 gph / 114 lph	45 gph / 170 lph
Gasoline or Diesel ¹	Both	Both	Both	Diesel	Diesel	Diesel
Vacuum Installation	Yes	Yes	Yes	Yes	Yes	Yes
Pressure Installation	Yes	Yes	Yes	Yes	Yes	Yes
Maximum PSI ² / kPa	100 psi / 690 kPa	7 psi / 48 kPa	7 psi / 48 kPa	30 psi / 207 kPa	30 psi / 207 kPa	30 psi / 207 kPa
Clean Pressure	0.15 psi	0.15 psi	0.01 psi	0.12 psi	0.31 psi	0.61 psi
Drop PSI/kPa	1.03 kPa	1.03 kPa	0.07 kPa	0.83 kPa	2.14 kPa	4.21 kPa
No. of Ports	4	4	2	3	3	3
Port Size	1/4" NPT/ M14 x 1.5	1/4" NPT/ M14 x 1.5	1/4" NPT/ M14 x 1.5	1/4" NPT/ M14 x 1.5	1/4" NPT/ M14 x 1.5	1/4" NPT/ M14 x 1.5
Integral Primer Pump ³	No	No	No	Yes	Yes	Yes
Replacement Element No. ⁴	R11	R12	R12	R15	R20	R25
Bowl/See-Thru	No	Yes	Yes	Yes	Yes	Yes
Bowl/Metal ¹	STD	Yes	Yes	Yes	Yes	Yes
Drain Type	Positive Seal	Positive Seal	Positive Seal	Positive Seal	Positive Seal	Positive Seal
Water Sensor Option ⁵	Yes	Yes	Yes	Yes	Yes	Yes
Electric Heater Option ⁵ (12V/24V)	No	No	No	Yes	Yes	Yes
Height	6" / 152 mm	6.5" / 166 mm	6" / 152 mm	8.3" / 211 mm	9" / 229 mm	10.5" / 267 mm
Width	3.2" / 81 mm	3.2" / 81 mm	3.2" / 81 mm	4" / 102 mm	4" / 102 mm	4" / 102 mm
Depth	3.2" / 81 mm	3.2" / 81 mm	3.2" / 81 mm	4" / 102 mm	4" / 102 mm	4" / 102 mm
Weight	1.3 lbs / 0.59 Kg	1.1 lbs / 0.50 Kg	1.1 lbs / 0.50 Kg	1.8 lbs / 0.80 Kg	2 lbs / 0.90 Kg	2.2 lbs / 1.0 Kg

- Notes: (1) Metal bowls should be used for gasoline installations.
 (2) Pressure installations are applicable up to the maximum PSI/kPa shown.
 (3) Models with integral primer pumps are not recommended for gasoline applications.
 (4) Replacement element micron rating can be specified as "S" for 2 micron, "T" for 10 micron, or "P" for 30 micron, except for R11.
 (5) Not for use with gasoline applications.

Racor Quality in One Easy Spin

- High-capacity, on-engine primary or secondary filtration
- Fits most existing mounting heads
- See-thru bowl with water sensor option
- Mounting heads available, contact Racor or your distributor

320 Engine Spin-On Series



Fuel Filter/ Water Separator w/ Reusable See-Thru Bowl	Spin-On Replace- ment Element (only)	Micron Rating		
B32001 Application: Cummins – 90 gph / Secondary (Final)	S3201	10	10.5"	267 mm
B32002 Application: DDC – 90 gph / Primary	S3202	30	10.5"	267 mm
B32003 Applications: Caterpillar – 60 gph / Secondary (Final) IH (Navistar) – 90 gph / Secondary (Final)	S3203	2	8.63"	219 mm
B32004 Application: IH (Navistar) – 40 gph / Secondary	S3204	30	7.13"	181 mm
B32006 Application: Caterpillar – 90 gph / Secondary (Final)	S3206	2	12"	305 mm
B32007 Application: Cummins – 180 gph / Secondary (Final)	S3207	10	13.5"	343 mm
B32008 Application: Deutz, Volvo – 30 gph	S3208	*	7.25"	184 mm
B32009 Application: Mann, DAF – 60 gph	S3209	*	8.63"	219 mm
B32011 Application: Cummins Short – 90 gph/Secondary (Final)	S3211	10	8.63"	219 mm
B32012 Application: DDC – 90 gph / 8.2L Primary	S3212	30	7.13"	181 mm
B32016 Application: Deutz, Volvo Short – 20 gph	S3216	*	5.85"	149 mm

* Available in 2, 10 or 30 micron.



4125 - 6125
3150 - 3250

High flow applications need not suffer with high maintenance... and Racor offers a range of ultra-high capacity, highly efficient fuel filter/water separators that also deliver spin-on convenience. As you'd expect, Aquabloc® II media is standard and all units provide flexibility in options to customize and meet specific operating conditions.

Model 3250R



HIGH FLOW				
MODEL	4125	6125	3150	3250
Maximum Flow Rate	120 gph / 454 lph	120 gph / 454 lph	150 gph / 570 lph	250 gph / 946 lph
Gasoline or Diesel ¹	Diesel	Both	Diesel	Diesel
Vacuum Installation	Yes	Yes	Yes	Yes
Pressure Installation	Yes	Yes	Yes	Yes
Maximum PSI ² /kPa	15 psi / 103 kPa	15 psi / 103 kPa	7psi / 50 kPa	7 psi / 50 kPa
Clean Pressure Drop PSI	0.85 psi	0.35 psi	0.68 psi	1 psi
No. of Ports	4	7	2	2
Port Size	3/4" SAE / 18 mm	3/8 NPT	0.875" X 14 SAE	0.875" X 14 SAE
Integral Primer Pump ³	Yes	No	No	No
Replacement Element No. ⁴	R125	R125	S3238P	S3207P
Bowl/See-Thru	Yes	Yes	Yes	Yes
Bowl/Metal ¹	No	No	Yes	Yes
Drain Type	Self-Vent	Self-Vent	Self-Vent	Self-Vent
Water Sensor Option ⁵	Yes	Yes	Yes	Yes
Electric Heater Option ⁵ (12V/24V)	Yes	Yes	Yes	Yes
Height	15 / 381 mm	14.12 / 359 mm	13.6 / 345 mm	17.25 / 438 mm
Width	4.5 / 114 mm	4.5 / 114 mm	5 / 127 mm	5 / 127 mm
Depth	4.8 / 121 mm	4.5 / 114 mm	5.5 / 140 mm	5.5 / 140 mm
Weight	3.9 lbs / 1.8 Kg	3.9 lbs / 1.8 Kg	3.6 lbs / 1.6 Kg	4.6 lbs / 2.08 Kg

- Notes:
- (1) Metal bowls should be used for gasoline installations.
 - (2) Pressure installations are applicable up to the maximum PSI/ kPa shown.
 - (3) Models with integral primer pumps are not recommended for gasoline applications.
 - (4) Replacement element micron rating can be specified as "S" for 2 micron, "T" for 10 micron, or "P" for 30 micron.
 - (5) Not for use with gasoline applications.



All Racor filter materials and seals are compatible with ultra-low sulphur diesel (ULSD) fuel and B2 to B20 Biodiesel.

See Racor bulletin #7679.

700 Series Integrated Filter/Separators

The Racor 700 Series is equipped with state-of-the-art fuel pumps with either brush or brushless DC motors. In brushless versions, the motor shaft directly drives the gerotor, creating a unique, positive displacement pump. The gerotor has fewer parts than gear or vane pumps, and the sensorless control technology of the brushless DC motor makes this product the most reliable filter and pump assembly on the market. The brushless pump assembly is ideal for tough on-engine

applications. For off-engine mounting, brushed pumps are a more economical alternative.

The 700 Series Integrated Fuel Filter/Water Separators have a two-stage filtration and repriming system. This complete fuel management system isolates contaminants present in diesel fuels and traps them prior to reaching the fuel injection system, protecting against costly and premature failure.

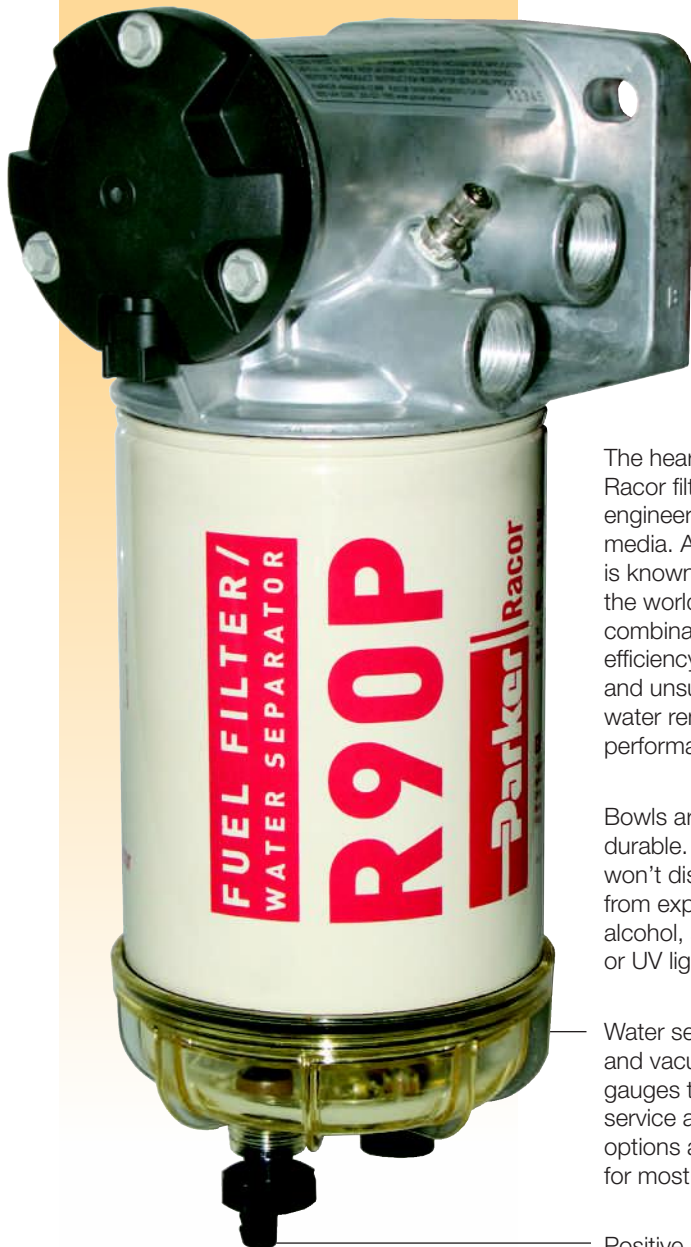

The heart of every Racor filter is the engineered filter media. Aquabloc II® is known around the world for its combination of high efficiency, long life and unsurpassed water removal performance.

Bowls are highly durable. They won't discolor from exposure to alcohol, additives or UV light.

Water sensor and vacuum gauges to signal service are valuable options available for most models.

Positive seal self-venting drain.

A rugged roller-cell pump. 60 gallons per hour flow rate while in priming mode.

100 micron pre-screen.

Unitized assembly only 3.3" tall.



12V DC or 24V DC motor.



MODEL	745R30	760R30	790R30 ¹	7125R10 ¹ (10 Micron)	7125R30 ¹ (30 Micron)
Maximum Flow Rate	45 gph / 170 lph	60 gph / 227 lph	90 gph / 341 lph	120 gph / 454 lph	
Gasoline or Diesel	Diesel	Diesel	Diesel	Diesel	
Replacement Element	R45P	R60P	R90P	R125T (10 Micron) R125P (30 Micron)	
Clean Pressure Drop	0.25 psi / 1.7 kPa	0.25 psi / 1.7 kPa	0.25 psi / 1.7 kPa	0.25 psi / 1.7 kPa	
Port Size	3/8" NPT	3/8" NPT	3/8" NPT	3/8" NPT	
Water Sensor Option	Yes	Yes	Yes	Yes	
Height	10.8 / 25.7 cm	11.8 / 28.4 cm	12.8 / 31.2 cm	15.8 / 40.1 cm	
Width	4.3 / 11.0 cm	4.3 / 11.0 cm	4.3 / 11.0 cm	4.3 / 11.0 cm	
Depth	6.5 / 16.5 cm	6.5 / 16.5 cm	6.5 / 16.5 cm	6.5 / 16.5 cm	
Weight (dry)	4.5 lbs. / 2.0 kg	5.5 lbs. / 2.5 kg	6.5 lbs. / 3.0 kg	7.7 lbs. / 3.5 kg	
Operating Temperature	-40° to +225°F (-40° to +107°C)				

¹The 700 Series comes in standard with a 12 volt brushed pump assembly. To order the 24 volt brushless pump assembly, insert 24 at the end of the 790 or 7125 part numbers. (example: 790R3024) Fuel pump for priming applications only. Not for continuous operation unless protected by a pre-filter.

For additional information about Racor Filter/Separator Pump Systems, request brochure #7683.

Fuel Conditioning Module



The patented P Series Diesel Fuel Conditioning Module (for vacuum side applications only) was developed for application in any diesel engine fuel injection system.

P Series assemblies are available in three sizes and all feature 3/8" NPT fuel ports. This innovative and modular fuel filter/water separator incorporates low-pressure fuel system components into a single package.

It supplies clean, dry fuel to the fuel system and serves as a repriming system.

Specifications	P3	P4	P5
Maximum Flow Rate	30 GPH (114 LPH)	40 GPH (151 LPH)	50 GPH (189 LPH)
Clean Pressure Drop	0.4 PSI (0.03 bar)	0.5 PSI (0.03 bar)	0.8 PSI (0.06 bar)
Max. Pump Output (at 14.4 volts)	40 GPH (151 LPH)	40 GPH (151 LPH)	40 GPH (151 LPH)
Standard Fuel Port Size (SAE J476)	3/8"-18 NPT	3/8"-18 NPT	3/8"-18 NPT
Total Number of Ports Available	2	2	2
Fuel Inlets	1	1	1
Fuel Outlets	1	1	1
Replacement Filter			
2 micron	R58060-02	R58095-2	R58039-2
10 micron	R58060-10	R58095-10	R58039-10
30 micron	R58060-30	R58095-30	R58039-30
Minimum Service Clearance	2.5 in. (6.4 cm)	2.5 in. (6.4 cm)	2.5 in. (6.4 cm)
Height	7.7 in. (19.6 cm)	9.0 in. (22.9 cm)	11.5 in. (29.2 cm)
Depth	5.2 in. (13.2 cm)	5.2 in. (13.2 cm)	5.2 in. (13.2 cm)
Width	4.8 in. (12.2 cm)	4.8 in. (12.2 cm)	4.8 in. (12.2 cm)
Weight (dry - approx.)	3.4 lbs (1.5 kg)	3.8 lbs (1.7 kg)	4.2 lbs (1.9 kg)
Maximum Pump Outlet Pressure	10 PSI (0.7 bar)	10 PSI (0.7 bar)	10 PSI (0.7 bar)
Features			
Water Sensor	Standard	Standard	Standard
Heater ¹	Standard	Standard	Standard
Pressure Regulator (10 PSI)	Standard	Standard	Standard
Ambient Temp Range	-40° to +255°F (-40° to +124°C)		
Maximum Fuel Temperature	190°F (88°C)		

Vacuum installations are recommended. ¹ Not for use with gasoline applications.

How To Order (The example below illustrates how part numbers are constructed).

P4	2	10	N	H
Specify Model P3 (for 30 GPH) P4 (for 40 GPH) P5 (for 50 GPH)	Must be in part number. Specifies a 12 vdc pump.	Specify micron rating: 02, 10, or 30	Must be in part number. Specifies 3/8" NPT ports.	Must be in part number. Specifies a 12 vdc 150 watt heater.

The high-grade aluminum components and powdercoat paints mean that corrosion is never a worry.

A durable single bolt mounting bracket doubles resistance to vibration fatigue.

Aquabloc® media sheds water and keeps engines waterproof, rustproof and dirtproof.

300-watt heaters start you in the cold. Thermostats are standard to meet the requirements of today's electronic engines.

Polymer bowl withstands impact and temperature extremes.

Self-venting drain. A single twist makes draining clean, fast and easy.

With an Aquabloc II® replacement element, you get a complete kit with all the seals you need.

Aquabloc II® media is a blend of high-grade cellulose compounded with resins and a special chemical treatment.

Aquabloc II® elements filter harmful tiny, particles of dirt and algae from fuel. Aquabloc II® elements are rustproof – with polymer end caps that won't ever corrode.

The First Name In Fuel Filtration.

Every engine runs better with a system that cleans fuel, removes water, heats fuel and senses when it's time for service. The system is the Racor Turbine Series and it's the most complete, most efficient, most reliable high-capacity engine protection you can install. A system that protects your investment in engines and fuel.

For marine rated filters, see brochure #7501.

Primer pump kit shown installed.
Order RKP1912 or RKP1924.

End caps are color-coded for easy identification and application – red for 30 micron primary filtration, blue for 10 micron primary or secondary, and brown for 2 micron secondary/final filtration.

Use original Racor filter elements to ensure premium performance.

An integral bail handle makes changeouts easy.

Our toll-free number is shown on the end cap. It puts you in touch with Racor's technical service staff who can answer any availability, application, or service question.



The Inside Story

1 As fuel enters, it moves past the internal check valve, then through the turbine centrifuge where it flows in a spiraling direction, spinning off large particulates and water droplets. Being heavier than fuel, the large particulates and water droplets fall to the bottom of the bowl.

2 Smaller water droplets bead-up along and on the sides of the internal components and on the surface of the Aquabloc® filter. When large enough, they too fall into the high-capacity bowl to be drained as needed.

3 Besides repelling water asphaltenes, algae, rust, and tiny solids from fuel. Aquabloc® filters are waterproof, so they remain effective longer, saving you money.

T-Handle Vacuum Indicator Kit For Turbine Series Assemblies

T-Handle vacuum restriction indicators monitor filter condition as the filter slowly becomes clogged with contaminants. As the filter gets dirty, restriction increases and less fuel is delivered to the engine causing the engine to lose power and eventually stall. By installing a vacuum indicator in your fuel system, visual monitoring of filter condition is possible at a glance, increasing fuel system troubleshooting efficiency, eliminating guess work, and lengthening filter changeout intervals.

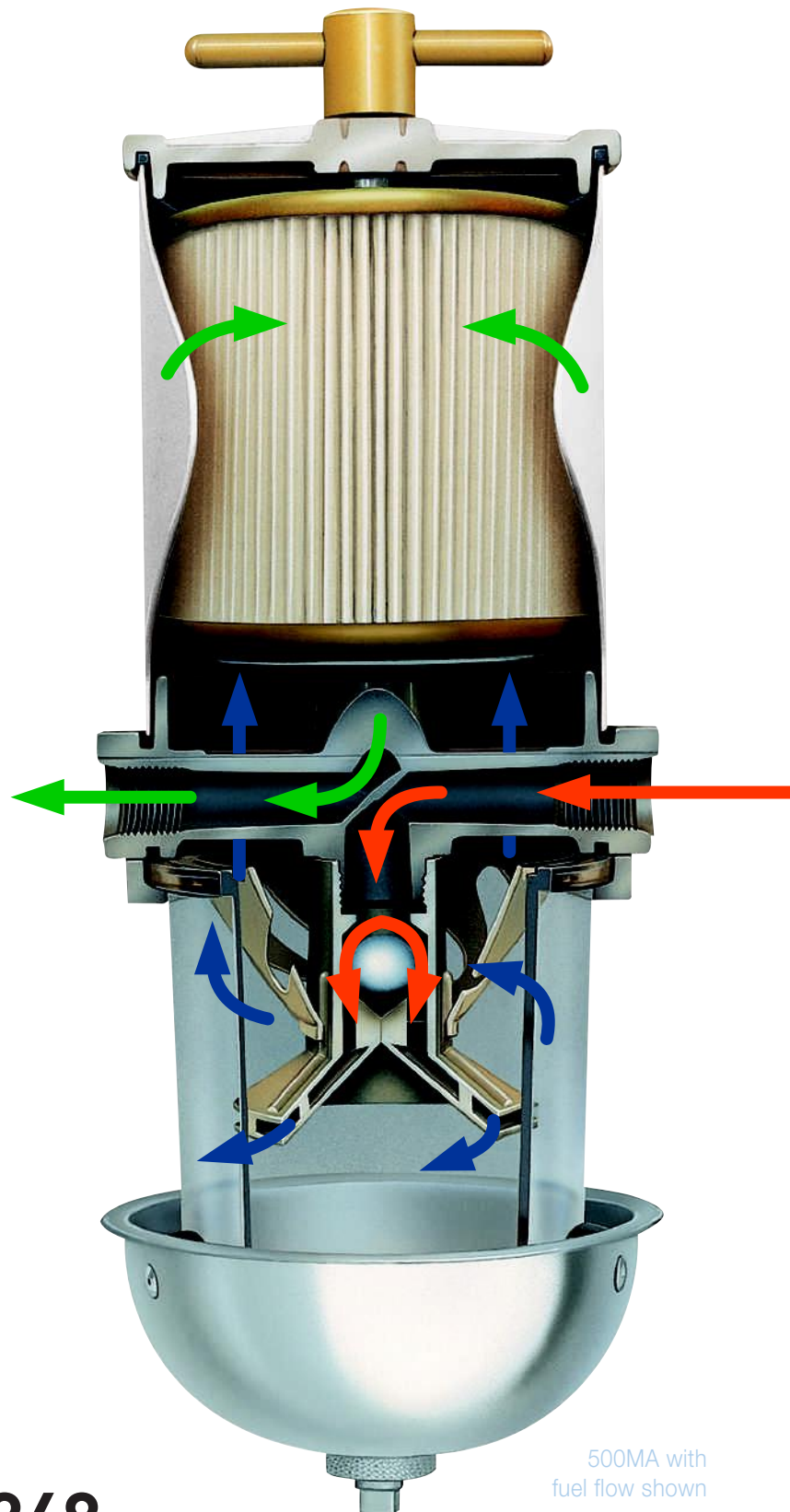

RK32348

This restriction indicator kit fits all Turbine Series Fuel Filter/Water Separator assemblies and installs in one easy spin.

2010PM-OR

2010 - 500 series | **SM** - 2 micron
2040 - 900 series | **TM** - 10 micron | **-OR** - O-ring pack
2020 - 1000 series | **PM** - 30 micron



Specifications	2010SM-OR 2010TM-OR 2010PM-OR	2020SM-OR 2020TM-OR 2020PM-OR	2040SM-OR 2040TM-OR 2040PM-OR
Micron Rating & Filtration Level	2010SM-OR, 2 Micron, Final Filtration 2010TM-OR, 10 Micron, Secondary 2010PM-OR, 30 Micron, Primary ¹	2020SM-OR, 2 Micron, Final Filtration 2020TM-OR, 10 Micron, Secondary 2020PM-OR, 30 Micron, Primary ¹	2040SM-OR, 2 Micron, Final Filtration 2040TM-OR, 10 Micron, Secondary 2040PM-OR, 30 Micron, Primary ¹
Height	2.7 in. (6.9 cm)	9.6 in. (24.4 cm)	4.6 in. (11.7 cm)
Diameter	3.1 in. (7.9 cm)	4.7 in. (11.9 cm)	4.7 in. (11.9 cm)
Applications	500MA-503MA	1000MA-1003MA	900MA-903MA
Notes: ¹ A secondary or final filter is required downstream. Replacement seals included.			

2020N-10

2040N - 900 series | **-02** - 2 micron
2020N - 1000 series | **-10** - 10 micron
-30 - 30 micron



The lower the micron rating the finer the filtration. Lower micron ratings should be considered when there is no additional downstream filtration.

Ultimately, the micron rating preferred will be a function of fuel quality, operating climates and maintenance schedules.

Specifications	2020N-02 2020N-10 2020N-30	2040N-02 2040N-10 2040N-30
Micron Rating & Filtration Level	2020N-02, 2 Micron, Final Filtration 2020N-10, 10 Micron, Secondary 2020N-30, 30 Micron, Primary ¹	2040N-02, 2 Micron, Final Filtration 2040N-10, 10 Micron, Secondary 2040N-30, 30 Micron, Primary ¹
Height	9.6 in. (24.4 cm)	4.6 in. (11.7 cm)
Diameter	4.7 in. (11.9 cm)	4.7 in. (11.9 cm)
Applications	1000MA-1003MA	900MA-903MA
Notes: ¹ A secondary or final filter is required downstream. Replacement seals included.		

MOBILE DIESEL

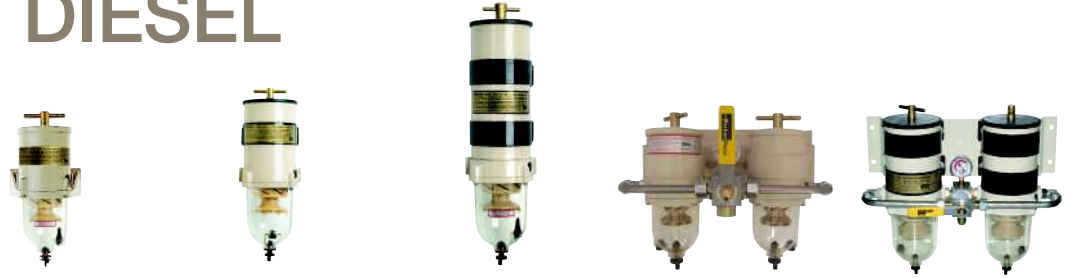

Model	500FG	900FH	1000FH	75500FGX	75900FHX
Max. Flow Rate (One filter on-line) (Two filters on-line)	60 GPH (227 LPH) N/A	90 GPH (341 LPH) N/A	180 GPH (681 LPH) N/A	60 GPH (227 LPH) 120 GPH (454 LPH)	90 GPH (341 LPH) 180 GPH (681 LPH)
Height	11.5 in. (29.2 cm)	17.0 in. (43.2 cm)	22.0 in. (55.9 cm)	11.5 in. (29.2 cm)	17.0 in. (43.2 cm)
Width	5.8 in. (14.7 cm)	6.0 in. (15.2 cm)	6.0 in. (15.2 cm)	14.5 in. (36.8 cm)	18.8 in. (47.8 cm)
Depth	4.8 in. (12.2 cm)	7.0 in. (17.8 cm)	7.0 in. (17.8 cm)	9.5 in. (24.1 cm)	11.0 in. (27.9 cm)
Weight (approx.)	4 lbs (1.8 kg)	6 lbs (2.7 kg)	17 lbs (7.7 kg)	17 lbs (7.7 kg)	23 lbs (10.4 kg)
Port Size (metric optional) ¹	3/4"-16 SAE 16 mm x 1.5	7/8"-14 SAE 22 mm x 1.5	7/8"-14 SAE 22 mm x 1.5	3/4"-16 SAE N/A	7/8"-14 SAE N/A
Clean Pres. Drop	0.3 PSI (0.02 bar)	0.34 PSI (0.02 bar)	0.49 PSI (0.03 bar)	0.70 PSI (0.05 bar)	1.7 PSI (0.12 bar)
Max. Operating Pressure ²	15 PSI (1.03 bar)	15 PSI (1.03 bar)	15 PSI (1.03 bar)	15 PSI (1.03 bar)	15 PSI (1.03 bar)
Replacement Filter	2010 Series	2040 Series	2020 Series	2010 Series	2040 Series
Overhead Clearance	4.0 in. (10.2 cm)	5.0 in. (12.7 cm)	10.0 in. (25.4 cm)	4.0 in. (10.2 cm)	5.0 in. (12.7 cm)
Ambient Temperature Range	-40° to +255°F (-40° to +124°C)				
Maximum Fuel Temperature	190°F (88°C)				

Notes: ¹ Use (*) for metric port threads, i.e. *500FG, *900FH, and *1000FH. ² Vacuum installations are recommended.



Model	731000FH	751000FH	771000FH	791000FH
Max. Flow Rate (One filter on-line) (Two filters on-line) (Three filters on-line)	N/A 360 GPH (1363 LPH) N/A	180 GPH (681 LPH) 360 GPH (1363 LPH) N/A	N/A N/A 540 GPH (2044 LPH)	180 GPH (681 LPH) 360 GPH (1363 LPH) 540 GPH (2044 LPH)
Height	22.0 in. (55.9 cm)	22.0 in. (55.9 cm)	22.0 in. (55.9 cm)	22.0 in. (55.9 cm)
Width	16.5 in. (41.9 cm)	18.0 in. (45.7 cm)	18.0 in. (45.7 cm)	21.5 in. (54.6 cm)
Depth	12.0 in. (30.5 cm)	11.0 in. (27.9 cm)	11.0 in. (27.9 cm)	11.8 in. (30.0 cm)
Weight (approx.)	26 lbs (11.8 kg)	30 lbs (13.6 kg)	39 lbs (17.7 kg)	52 lbs (23.6 kg)
Port Size	3/4"-14 NPT	7/8"-14 SAE	1"-11.5 NPT	3/4"-14 NPT
Clean Pres. Drop	1.7 PSI (0.12 bar)	3.7 PSI (0.26 bar)	1.7 PSI (0.12 bar)	2.5 PSI (0.17 bar)
Max. Operating Pressure ³	15 PSI (1.03 bar)	15 PSI (1.03 bar)	15 PSI (1.03 bar)	15 PSI (1.03 bar)
Replacement Filter	2020 Series	2020 Series	2020 Series	2020 Series
Overhead Clearance	10.0 in. (25.4 cm)	10.0 in. (25.4 cm)	10.0 in. (25.4 cm)	10.0 in. (25.4 cm)
Ambient Temperature Range	-40° to +255°F (-40° to +124°C)			
Maximum Fuel Temperature	190°F (88°C)			

Notes: ³ Vacuum installations are recommended.

GreenMAX™

Heavy-Duty, High-Capacity, Fuel Filter Water Separator With Options for All-Weather Operations



Integrated Piston-Style Hand Priming Pump or Fill Port

Hot Engine Return Fuel Recirculating Heater

Dual Inlet / Outlet Ports

Low Restriction at High Flow Rates

Optional 300W Electric In-Head Heater

Patented Filter Valve Mechanism Holds Prime and Prevents Clean Side Contamination During Service

Durable Multi-Port Cast Aluminum Mounting Head Assembly

Easy to Mount with Through-Holes for a 3/8" Bolt and Tapped for a M8 Bolt

Aquabloc High-Capacity, High-Flow Filter Element

Rated Diesel Flow Rate Change to 150 gph (568 lph)

Optional 200W Electric In-Bowl Fuel Heater for Severe Cold Conditions (Not Shown)

High-Capacity Removable, Reusable and Extremely Durable Bowl - A See-Thru Bowl That Stays See-Thru

Water-In-Fuel (WIF) Water Sensor Alerts Operator for Service (1/2-20 SAE Port)

FIRST FIT	DESCRIPTION
4400R02	GreenMAX FF/WS, W/Hand Primer Pump, 2 Micron
4400R10	GreenMAX FF/WS, W/Hand Primer Pump, 10 Micron
4400R30	GreenMAX FF/WS, W/Hand Primer Pump, 30 Micron
4400R1202	GreenMAX FF/WS, 12v in bowl heater, W/Hand Primer Pump, 2 Micron
4400R1210	GreenMAX FF/WS, 12v in bowl heater, W/Hand Primer Pump, 10 Micron
4400R1230	GreenMAX FF/WS, 12v in bowl heater, W/Hand Primer Pump, 30 Micron
4400R2402	GreenMAX FF/WS, 24v in bowl heater, W/Hand Primer Pump, 2 Micron
4400R2410	GreenMAX FF/WS, 24v in bowl heater, W/Hand Primer Pump, 10 Micron
4400R2430	GreenMAX FF/WS, 24v in bowl heater, W/Hand Primer Pump, 30 Micron
4400R1210-01	GreenMAX FF/WS, W/Hand Primer Pump, 12 VDC Bowl Heater, 10 Micron, Return Fuel Heat
4400R2410-01	GreenMAX FF/WS, W/Hand Primer Pump, 24 VDC Bowl Heater, 10 Micron, Return Fuel Heat
6600R02	GreenMAX FF/WS, 2 Micron
6600R10	GreenMAX FF/WS, 10 Micron
6600R30	GreenMAX FF/WS, 30 Micron
6600R1202	GreenMAX FF/WS, 12v in bowl heater, 2 Micron
6600R1210	GreenMAX FF/WS, 12v in bowl heater, 10 Micron
6600R1230	GreenMAX FF/WS, 12v in bowl heater, 30 Micron
6600R2402	GreenMAX FF/WS, 24v in bowl heater, 2 Micron
6600R2410	GreenMAX FF/WS, 24v in bowl heater, 10 Micron
6600R2430	GreenMAX FF/WS, 24v in bowl heater, 30 Micron
6600R1210-01	GreenMAX FF/WS, 12 VDC Bowl Heater, 10 Micron, Return Fuel Heat
6600R2410-01	GreenMAX FF/WS, 24 VDC Bowl Heater, 10 Micron, Return Fuel Heat
SERVICE	DESCRIPTION
R61691S	Element Assembly, GreenMAX 2 Micron
R61691T	Element Assembly, GreenMAX 10 Micron
R61691P	Element Assembly, GreenMAX 30 Micron
RK6166804	Engine Return Fuel Heat Kit
RK6166301	Clear Bowl Kit, No Heater
RK6166312	Clear Bowl Kit, 12 VDC Heater
RK6166324	Clear Bowl Kit, 24 VDC Heater
RK61713	Fuel Port Plug Replacement Kit
PFRK61730	Bowl Wrench
RK 30876	Heater Connector Kit
RK2012601	WIF Plug Kit
RK22100	Fill Port Plug Kit (6600 Only)

GreenMAX™ Fuel Filter Water Separator	
Rated Flow Rate	150 GPH (568 LPH)
No. of Ports	Inlet Ports: 2, Outlet Ports: 2
Port Size	-10 SAE (7/8-14 UNF)
Hand Primer Pump	Optional
Micron Rating Available	2, 10, 30
Particulate Removal Efficiency (SAE J1985)	Min 98% (R61691T)
Water Removal Efficiency (SAE J1839)	Min 99% (R61691T)
Return Fuel Heat Valve (Thermostatically Controlled)	Optional: -8 SAE 45° Flare (3/4-16)
Electrical Heater 12 or 24 vdc	Optional (300W/200W)
Water Sensor	Optional (1/2-20 SAE port)
Vacuum (Maximum)	20" Hg
Ambient Temperature Range	-30° to +100° C
Maximum Fuel Temperature	
With Bowl Heater	71° C
Without Bowl Heater	85° C
Fuel Compatibility	Diesel fuel per ASTM D975 and Biodiesel blends up to B20 per ASTM D7467
Fuel Filter Change Indicator	Vacuum Gauge/Filter Minder/Vacuum Switch

Three heating options, including a patented engine return fuel recirculating technology, deliver free-flowing fuel even in the most severe weather conditions.

Cold Start In-Head and In-Bowl Electric-Thermostatically Controlled Fuel Heating Options

To bring fuel quickly to operating temperatures in very cold conditions, optional 300W in-head heater and a 200W in-bowl heater are available. Both are thermostatically controlled and self-regulating, automatically shutting down once target fuel temperature is achieved.



To summarize GreenMax fuel heating options: Electric heaters help you get started; hot fuel recirculating keeps you running.

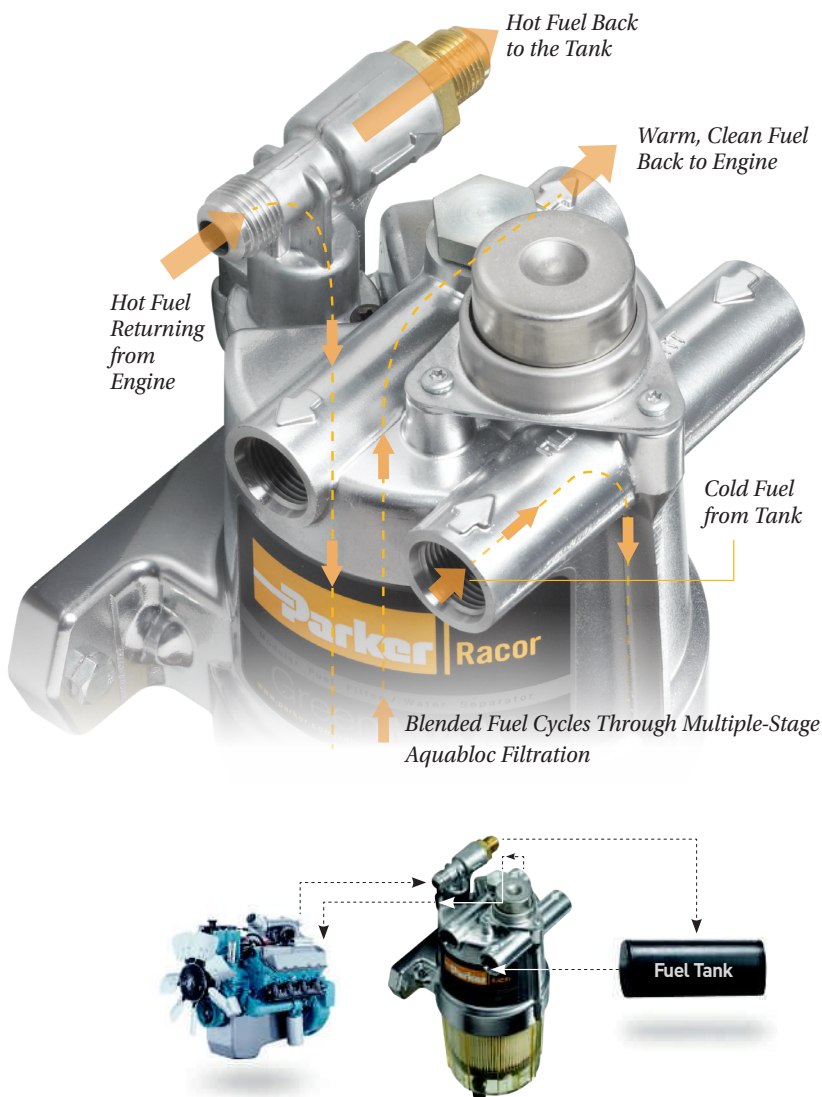

Engine Return Fuel Recirculation

The GreenMAX Fuel Filter Water Separator features an innovative patented technology that utilizes unused warm engine fuel returning to the tank to provide on-demand fuel heat transfer for cold weather operations. This cold weather feature melts the wax and paraffins that separate from diesel fuel at cold temperatures (cloud point) and restrict fuel flow during the filtration stage.

The recirculating valve is self-regulating, sensing fuel temperature and automatically closing once the fuel is warm, and returns hot fuel to the tank.

This option includes a fuel recirculation valve that is thermostatically controlled to direct engine return fuel into the GreenMAX prior to the filtration stage.

The engine return fuel is mixed with the GreenMAX incoming fuel flow from the fuel tank, providing optimum fuel temperature for efficient fuel filtration and engine performance.

When the fuel system temperature is stabilized for optimum fuel filtration and engine operation, the engine return fuel recirculation valve automatically redirects the engine return fuel to the fuel tank.

SNAPP. The fuel filter change that changes everything.

SNAPP is big protection for small engines with fuel flows up to 26 gph and makes every filter change literally a snap. Fast, easy, clean. No tools are needed – when it’s time for service, simply snap in a new filter. Simple installation and a patented priming system mean that protecting your engine investment is now ... a SNAPP.



Fast, easy, clean, SNAPP is a fuel filter change for the better.

The world turns to Racor for filtration solutions that provide ultimate protection from water and solid contamination. This is filtration that includes two innovations often copied but never quite duplicated – the powerful protection of patented, world-class Aquabloc® filter media and, the Racor trademark, a clear bowl that allows for at-a-glance inspection of fuel system integrity.



Quick-release squeeze tabs make filter changes a snap.

Permanent mounting bracket is stainless steel for withstanding corrosive environments.

SNAPP is a one-piece fuel filter water separator for 24/7 protection .

Heavy-duty high-impact nylon construction won't ever rust or corrode, even in humid conditions.

Clear bowl for at-a-glance inspection.

The rugged clear bowl allows on-the-spot inspection for water in fuel – a significant advantage when troubleshooting fuel quality.

The Racor self-venting drain means easy service with no mess – twist, drain, done.

Legendary Aquabloc® filter media in 2, 10 or 30 micron rating.

The Aquabloc® media is the world's definitive filtration protection – it's 99% effective in separating water and solid contamination from marine and diesel fuels.

Mobile SNAPP First Fit Assembly	Mobile SNAPP Replacements
23106-02	R23107-02
23106-10	R23107-10
23106-30	R23107-30

Specifications	
Maximum Flow Rate	26 gph (100 lph)
Aquabloc Micron Rating	2, 10, or 30 micron
Height	7.8" (198 mm)
Width	3.8" (97 mm) at bracket
Depth	4.1" (104 mm)
Water Sump Capacity	3.4 oz. (100 ml)
Body Material	Nylon 6 plastic
Bracket Material	Coated Steel
Port Size	3/8" (9.5 mm)
Quick-Connect Fittings	3/8" (9.5 mm) (per SAE J2044)
Rated Pressure	50 PSI (3.5 bar)
Water Removal Efficiency	99%
Rated Temperature Range	-20° to 150°F (-29° to 66°C)

In-Line Fuel Filtration

From personal watercraft to agricultural equipment, Racor in-line filters are designed to protect fuel pumps, carburetors, injectors and related fuel system components. We offer a complete range of disposable and cleanable in-line filters and prescreen products that work for diesel and gasoline applications.



MODEL NO.	025-RAC-01	025-RAC-02	025-RAC-10	025-RAC-11	025-RAC-12	PS120
Maximum Flow Rate	25 gph (95 lph)	25 gph (95 lph)	50 gph (189 lph)	15 gph (57 lph)	15 gph (57 lph)	120 gph (454 lph)
Maximum PSI/ kPa	5 psi (35 kPa)	5 psi (35 kPa)	5 psi (35 kPa)	5 psi (35 kPa)	5 psi (35 kPa)	5 psi (35 kPa)
Clean Pressure Drop	0.26 psi (1.8 kPa)	0.35 psi (2.4 kPa)	0.5 psi (3.5 kPa)	0.5 psi (3.5 kPa)	0.5 psi (3.5 kPa)	0.25 psi (1.7 kPa)
No. of Ports	2	2	2	2	2	2
Port Size	1/4" NPT	1/4" NPT	1/2" NPT	1/4" Barb	5/16" Barb	3/8"
Height	4.3 in. (109.2 mm)	4.3 in. (109.2 mm)	4.75 in. (120.7 mm)	3.45 in. (99.6 mm)	3.45 in. (99.6 mm)	7.25 in. (184.2 mm)
Width	2.25 in. (57.2 mm)	2.25 in. (57.2 mm)	4.19 in. (106.4 mm)	2.10 in. (53.3 mm)	2.25 in. (57.2 mm)	4.0 in. (101.6 mm)
Depth	2.10 in. (53.3 mm)	2.10 in. (53.3 mm)	1.88 in. (47.6 mm)	2.10 in. (53.3 mm)	2.10 in. (53.3 mm)	3.0 in. (76.2 mm)
Weight	0.3 lb (136 g)	0.3 lb (136 g)	0.3 lb (136 g)	0.3 lb (136 g)	0.3 lb (136 g)	0.75 lb (340 g)
Replacement Element	S2501	S2502	N/A	N/A	N/A	N/A

Fuel Filter Funnel

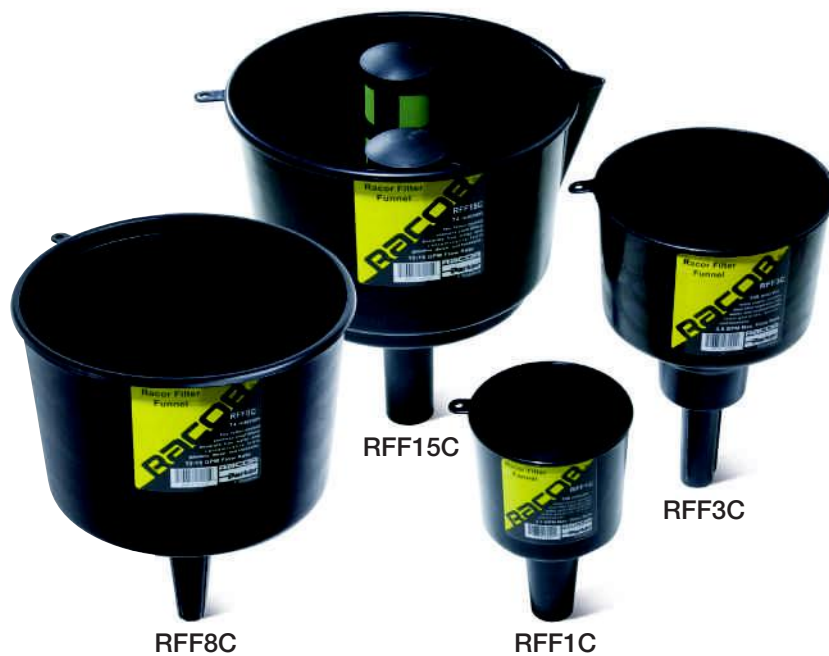

Racor Filter Funnel (RFF) is a heavy-duty, fast-flow, filter-in-a-funnel that separates damaging free water and contaminants from gasoline, diesel, heating oil, and kerosene.

The RFF family of products is capable of removing free water and solids down to 0.005 inches and allows you to visually inspect the integrity of your fuel supply as you refuel.

The RFF family is manufactured using industrial-grade black electro-conductive polypropylene. Carbon powder is injected into the plastic so that the RFF will conduct static electricity. The grounding capability of the RFF is an important safety feature. Always use proper fuel handling procedures and follow local, state, and federal regulations.

Caution for Users: Petroleum products flowing over a plastic surface generate static electricity. Caution should be taken to ensure that the RFF is grounded to reduce static electricity buildup and reduce the chance of explosions or fire. Electrically bond the funnel by using a wire with a metal clip on each end and clamp one to the upper rim of the funnel and the other to the fueling source. For example, the metal gas can or nozzle from the pump.

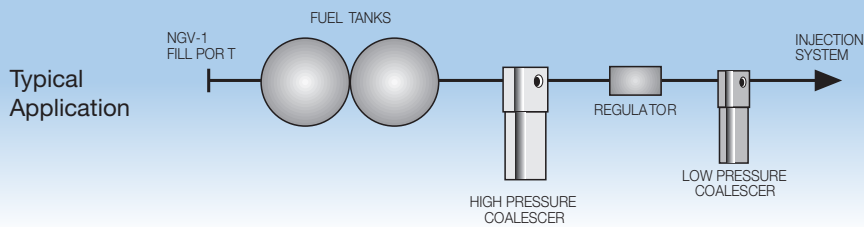

	LOW			MEDIUM	HIGH	
MODEL	FFC-110-06	FFC-112-SAE	FFC-110L-10	FFC-112	FFC-113	FFC-114
Type	Coalescer	Coalescer	Coalescer	Coalescer	Coalescer	Coalescer
Port	1/4" NPT	9/16 SAE	1/4" NPT	1/4" NPT	1/2" NPT	1/2" NPT
PSI (max.)	500 PSI	500 PSI	500 PSI	3600 PSI	3600 PSI	3600 PSI
Rated Flow	25	25	50	15	50	50
Length	7.16" / 181.86 mm	7.16" / 181.86 mm	10.4" / 264.16 mm	4.75" / 120.65 mm	8.03" / 203.96 mm	6.98" / 177.29 mm
Diameter	3.13" / 79.50 mm	3.13" / 79.50 mm	3.13" / 79.50 mm	2.25" / 57.15 mm	2.97" / 75.43 mm	2.97" / 75.43 mm
CNG	•	•	•	•	•	•
LNG			• ²		• ³	• ³
LPG	•	•	•			
Weight	1.5 lbs / .68 kg	1.5 lbs / .68 kg	1.8 lbs / .82 kg	1.5 lbs / 0.68 kg	5.5 lbs / 2.49 kg	5.25 lbs / 2.3 kg
Element	CLS110-10	CLS110-10	CLS110-10L	CLS112-10	CLS113-6	CLS113-6
Sump Capacity Oz.	5.0	5.0	7.0	0.5	5.0	3.0
Material	Painted Steel	Painted Steel	Painted Steel	Stainless Steel	Anodized Aluminum	Stainless Steel

Notes: (1) Use in conjunction with coalescer. (2) Low flow rate LNG applications. (3) Medium flow rate LNG applications. Bypass included. (4) High flow rate LNG applications. Bypass included. (5) SCFM at 100 PSIG.

Today's alternative fuels - compressed natural gas, liquid natural gas and liquid propane gas - have the same problems that plague diesel and gasoline... contamination that collects during handling, water that condenses in tanks and compressors that leak oil into the fuel stream.

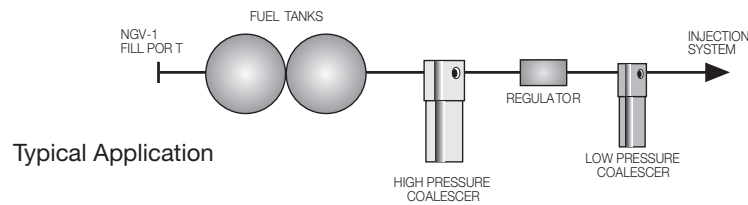

Low Pressure Fuel Filter/Coalescers

Low pressure coalescers are ideal for operating environments up to 500 psi. All aerosol contaminants in the 0.3 to 0.6 micron range are filtered to an efficiency level that exceeds 95%.



High Pressure Fuel Filter/Coalescers

These patented coalescing filters are constructed to withstand operating pressures to 3,600 psi while removing over 95% of aerosols in the 0.3 to 0.6 micron range.

Protecting the fuel injectors and components of an alternative fuel system is vital to efficient vehicle operation. Racor offers the most complete line of fuel filter/coalescers and prefilter/strainers for on-vehicle applications. These filters ensure removal of damaging aerosol contamination as small as 0.3 to 0.6 micron and exceed 95% efficiency, depending on the grade of element specified. Units are available in a range of pressure ratings and are constructed of aluminum, stainless steel or painted steel. The fuel filter/coalescer elements are produced by a patented process of arranging microglass fibers into a tubular form. During operation, fuel is forced through the coalescing media from the inside of the cartridge through the tubular wall to the outside, where the large droplets fall to the bottom of the housing. Oily water emulsion accumulates until drained while the dirt particles remain trapped on the surface of the fibers.



Versatile RV Series

Racor RV Series filter vessel applications include removing liquid and solid contaminants from diesel fuel, gasoline, kerosene, aviation gas, jet fuel and other lubricating or hydraulic oils. RV vessels utilize proven filter design technology and can be used as a coalescer/separator, water absorber or clay treater by changing internal components, flow direction, or by selecting optional filter cartridges when ordering. The vessels are fabricated from carbon steel with an exterior primer coating of Gavlon suede gray and the interior is epoxy coated to meet MIL-C-4556E.

Element choices include a coalescer/separator, pre-filter, water absorber or clay treater. Completely dressed factory filter vessels can be specified with differential pressure gauges, water sight glasses, air eliminators, and manual or automatic drains. Wall mount units can be special ordered.

See bulletin #7648 for the full line of high flow filtration products.



Model RVFS

Features

- Carbon steel construction; other materials are available.
- 250 psi ASME Code, Section VIII construction, stamped and certified.
- Yellow zinc-plated swing bolt closure.
- Buna-N O-ring cover seal.
- Interior: Epoxy-coated MIL-C4556 E.
- Exterior: Prime coated.
- Knife-edge cartridge mounting seals.

Connections

- Inlet and outlet: 2" NPT.
- Main drain and liquid level ports: 1/2 inch"
- Vent and pressure relief connection: 3/4" NPT.
- Differential pressure gauge/sample ports: 1/8" NPT.

Spin-On Protection At The Pump

Racor's Fuel Dispensing Filters are essential for stationary and overhead tanks and mobile service vehicles, so you can start protecting your investment at the source. With their easy-to-install heads, they remove virtually 100% of the contaminants from diesel fuel. Racor elements feature a super-absorbent, chemically treated media that absorbs 25 times its weight in water, "locking it in" as a barrier against free and emulsified water. There is no bypass valve, which ensures that fuel is completely protected. As the media swells, it significantly reduces the fuel flow rate, signaling a need to replace the element.



Racor offers filter protection down to 25 microns. Flow rates range from 15 to 100 gpm. Element service is clean and easy – there's no cartridge to replace – just spin-on a new Racor filter element.

Fuel dispensing filters can be used with diesel fuel or gasoline.

FBO Filter Cart

New to the FBO family of filters is the Racor heavy duty Fuel Recycler Cart. The filter cart polishes, cleans up, and recycles old or contaminated fuel. It can be used in preventative maintenance as a servicing unit. The all aluminum construction keeps it lighter for mobility purposes, while being durable and corrosion resistant for many years of operation.



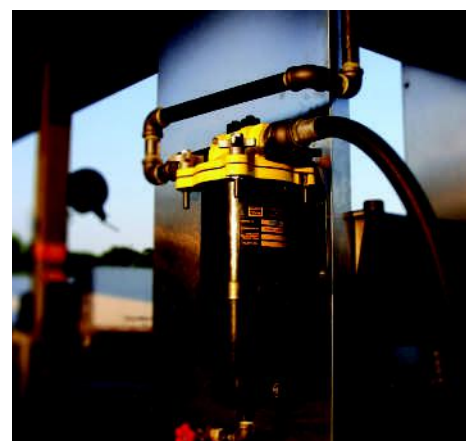
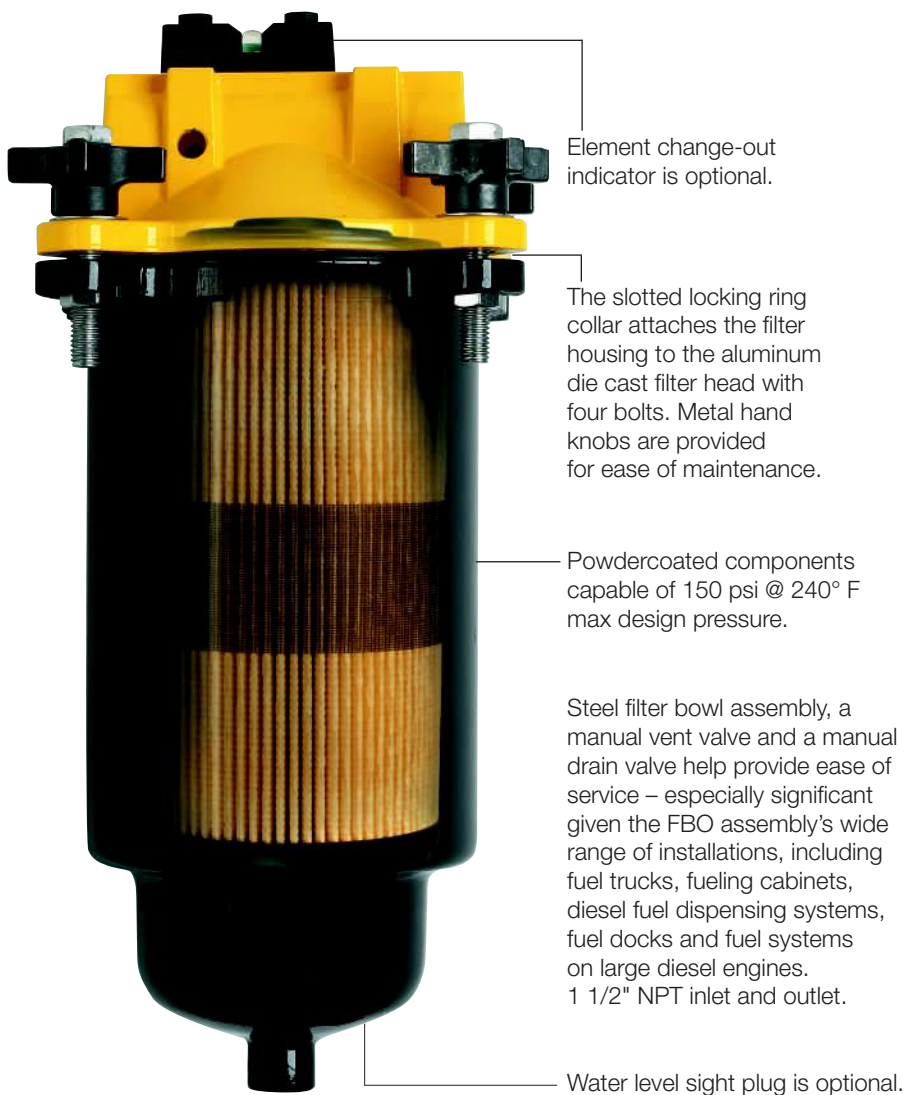

FBO Filter Assembly

Racor's FBO-10 and FBO-14 filter assemblies are designed to meet the toughest hydrocarbon refueling conditions and provide for ease of filter change-outs. The FBO Assembly can flow 25 gpm/95 lpm or up to 75 gpm/230 lpm depending on the model, the elements installed and fuel being filtered.

The assembly features a locking ring collar, which attaches the filter housing to the aluminum die cast filter head with four bolts. The slotted locking ring collar allows maintenance personnel to hand-loosen the four collar bolts, rotate and lower the bowl assembly for element change-outs. With new element installed, simply raise the bowl and rotate into position on the locking ring and hand tighten evenly.

The closure hardware consists of stainless steel nuts, bolts and washers with metal hand knobs for ease of maintenance – one person can easily change the filter element. No wrenches or other special tools are required.

Performance Specifications

FBO-10	Maximum Flow Rates			Clean Dry	Change
	Flow Range	Diesel	Gasoline	Delta P	Delta P
Prefilter	5-40 gpm	20	50	**	20 PSID
Filter Sep	5-35 gpm	18	45	**	15 PSID
Absorber	5-25 gpm	18	45	**	30 PSID
FBO-14	Flow Range	Diesel	Gasoline	Delta P	Delta P
Prefilter	10-60 gpm	30	75	**	20 PSID
Filter Sep	10-50gpm	25	65	**	15 PSID

**Varies with fluid and flow rate.

Biodiesel and other biofuels require extra heat, filtration, and vehicle modifications to burn in diesel engines. Racor fuel filters and heaters are uniquely suited for filtering and conditioning biodiesel and biofuels for use in diesel engines.





Racor Engineering Expertise

Racor has participated in several biodiesel filtration field tests with major OEMs. Racor is actively participating in industry-wide research and development on biodiesel fuel filtration and water separation challenges. Development of technology to support the use of all biofuels is ongoing at Racor.

Challenges and Solutions

Biodiesel tends to shorten filter life and most biodiesels have a low “interfacial tension” – meaning water easily disperses and dissolves in the fuel, greatly reducing efficiency for all types of water separators and coalescers. Racor recommends using the largest filter practical for the application to extend filter life and increase efficiency. When specifying a new biodiesel fuel system, de-rate fuel filter flow by 50% and install on the vacuum side of any pumps, where possible.

Racor Fuel Filtration Systems Recommended for Biodiesel/Biofuels

<p>FUEL DISPENSING</p>  <p>FBO RVFS</p>	<p>ELECTRIC HEATED PRIMARY FILTRATION</p>  <p>6120R1230 1000FH1230</p>
<p>COOLANT HEATED PRIMARY FILTRATION</p>  <p>390RC30</p>	<p>ELECTRIC HEATED SECONDARY FILTRATION</p>  <p>6120R122 660R1210</p>
<p>COOLANT TO FUEL HEAT EXCHANGER</p> <p>320HTR4</p> 	

In cold weather, Racor recommends using at least 200 watts of thermostatically controlled electric heating in the head and/or filter bowl. Pour point suppressants and biocides are also necessary for reliable operation and a coolant heat exchanger is required in extreme cold weather conditions.

Racor’s ultra high quality synthetic rubber compounds perform equally well in biodiesel and standard diesel. Seals subject to biodiesel exposure are generally replaced at the same time as the replacement filter. Racor uses all materials compatible with up to 20% biodiesel blend. Above 20% may require material changes to dynamic seals that are not normally replaced at element change-outs.

Biodiesel and Biofuel Filtration Specification Considerations

- 1 Large primary and secondary filters at 50% of their rated flow.
- 2 High-quality, corrosion-resistant materials in construction.
- 3 High-quality, synthetic rubber compounds for seals and hoses.
- 4 Efficient coolant and/or electric heating.
- 5 Fuel source with high-efficiency fuel dispensing.

All Racor filter materials and seals are compatible with ultralow sulphur diesel (ULSD) fuel and B2 to B20 Biodiesel.

300RC Series

The 300RC Series Diesel Fuel Filter/Heater/Water Separators are specifically designed to handle today's tough cold weather and Biodiesel fuel system problems. These units feature a standard high-efficiency coolant heat exchanger to heat incoming fuel.

- High-capacity media – the Racor Aquabloc® II media allows for excellent contaminant removal and water separation. Available in 2,10, and 30 micron ratings.
- Highly efficient heaters – utilizing heat from the engine's coolant, the heat exchanger transfers heat to the fuel quickly and efficiently.
- Highly efficient water coalescing.
- Biodiesel tested rubber seals and gaskets to prevent swelling.



390RC



MODEL	345RC	360RC	390RC
Fuel Ports	3/8 NPTF	3/8 NPTF	3/8 NPTF
Replacement Element	R45	R60	R90
Flow Rate	45 gph / 170 lph	60 gph / 227 lph	90 gph / 341 lph
Height	8.7" / 221 mm	10.4" / 264 mm	11.25" / 286 mm
Width	4" / 102 mm	4" / 102 mm	4" / 102 mm
Depth	4.8" / 122 mm	4.8" / 122 mm	4.8" / 122 mm
Temperature	-40°F / +255°F -40°C / +121°C	-40°F / +255°F -40°C / +121°C	-40°F / +255°F -40°C / +121°C



Compact Fuel Heater

Plumbed into the fuel upstream from filters, the coolant heater is another compact way to run through the cold. An optional internal thermostatically-controlled valve allows fuel to bypass the heater once it has reached operating temperature. Depending on fuel flow rate, you can get as much as 89°F heat rise. Like its electric partner, there are no moving parts, nothing to rust or corrode.



Coolant Heaters

The Racor ECH™ tank-type coolant heaters operate using the thermo-siphon circulation principle. Heated coolant is returned to the engine as colder coolant is drawn into the heater. By utilizing standard alternating current (AC) from the customer-supplied source, they heat and maintain the engine coolant at a pre-determined temperature range. This warm coolant helps keep the engine ready for instant operation. Racor ECH™ tank type coolant heaters are mounted off the engine for long life and increased wattage output.

Note: Not for use as fuel heaters.



Why you need a Racor fuel heater.

All diesel fuels (other than #1) contain dissolved waxes. At cold temperatures the wax crystallizes, leading to filter plugging and fuel gelling. These changes greatly reduce fuel flow, adversely affecting the operability of vehicles.

With the increased popularity of biodiesel, and the use of ultra low sulfur diesel (ULSD), there are new cold weather challenges. While proper fuel winterization normally avoids trouble, both biodiesels and ULSD may experience wax crystallization and gelling at higher than expected temperatures and contribute to cold fuel flow problems anyway.

Keeping this in mind, it is more necessary now than ever to design an efficient fuel heating system for all cold weather applications.

Racor offers a number of efficient heaters. Compact coolant and electric heaters install in minutes, yet deliver years of trouble-free service. There is even an in-line heater which actually turns a fuel line into a heated path from tank to filter.

Spin-On Series In-Bowl Heaters

Racor equips the Spin-On Series fuel filter/water separators with the option of a 200W resistance heater integrated into the bowl. Placing the heat source just below the element allows for maximum transfer. Racor Spin-On Series In-Bowl heaters are available installed in assembly upon order (consult catalog for part numbers) or as a retrofit kits.



Spin-On Series In-Bowl Heaters

Part No.	RK 22354-01	RK 22354-02	RK 30900	RK 30925
Heater Retrofit Kit For	200 Series	200 Series	3150, 3250, 4120, 6120	3150, 3250, 4120, 6120
Wattage	200W	200W	200 W	200W
Voltage	12V	24V	12V	24V
Bowl Type	Clear	Clear	Clear	Clear

Part No.	RK 22616-01	RK 22616-02	RK 30895	RK 30924
Heater Retrofit Kit For	300RC, 400, 600 Series	300RC, 400, 600 Series	320 Series	320 Series
Wattage	200W	200W	200 W	200W
Voltage	12V	24V	12V	24V
Bowl Type	Clear	Clear	Clear	Clear

Turbine Series Heater

The Racor Turbine Series comes available with a powerful heater situated directly below the filter element to assist with cold starting. Thermostats are standard to meet the requirements of today's advanced electronic engines. These heaters begin to work in just a few moments and place minimal demand on the battery. Racor Turbine Series heaters are available installed in assembly upon order (consult catalog for part numbers) or as a retrofit kits.



300 Series In-Head Heater

The in-head 150W heater is a cold weather aid and is thermostatically controlled when power is provided. The heater will automatically turn on if the fuel temperature drops below 45°F (7°C) and will automatically turn off at 75°F (24°C). Heat is supplied directly below the inlet port to melt the wax crystals and allow fuel to efficiently pass through the element. The heater is operated by turning the ignition switch on for a minimum of five minutes prior to starting the engine.



Consult catalog for part numbers.

Thermoline™ In-Fuel-Line Heater

The heavy-duty Thermoline™ Diesel Fuel Heater comes installed inside a new fuel line and literally replaces the fuel line between the tank and the primary filter. It prevents power loss and stall, and assists starting down to -40°F. This heated path is recommended for extended use in cold weather environments and severe conditions.

Thermoline In-Fuel-Line Heater comes factory pre-wired with all hardware, ready for quick installation.

Consult catalog for part numbers.



Nomad Electric Heaters



The Racor Nomad Diesel Fuel Heater is available in 300 and 500 watts and is one of the most compact, most efficient ways to heat fuel on the road today.

Installation usually takes about an hour. An optional frame rail mounting bracket eliminates drilling and welding.

Consult catalog for part numbers.

Features and Benefits

- Durable and compact WIF housing
- 1/2"-20 UNF threads with SAEJ1926 o-ring seal design
- Hermetically sealed against water and fuel
- Use with 12 or 24 vdc
- Gold plated brass probe tips
- Corrosion proof materials
- Color-coded for easy visual identification
- WIFs include mating, detachable and locking wire harness connectors

Water Detection Probes

Racor's Water-In-Fuel (WIF) Probes are designed to be robust and feature gold plated metallic probe tips and water tight, detachable and locking wiring harness connectors.

Water probes are passive sensors that work in conjunction with active electronic detection amplifiers. The probes are installed in the bottom of Racor fuel filter/water separator contaminant collection bowls. When accumulated water levels rise to the level of the metallic probe tips, the detection amplifier analyzes the change in electrical resistance (in ohms) and activates an alarm or lamp (depending on the detection amplifier used).

The WIF probes are available in three versions and colors. The version chosen depends on the equipment's Electronic Control Module (ECM) requirements; 83K ohms (blue body) or 220K ohms (black body). For applications not requiring this match, the non-resistor version (green body) should be used.

Detachable Locking Wire Harness

The detachable wire harness adds a convenience to remove the connection when servicing the spin-on filter or contaminant collection bowl. To remove, slide the red "safety-lock" away from the WIF probe. Next, press down on the black tab lever and pull the connector away from the WIF. To reconnect, just push the harness connector onto the WIF. It is specially "keyed" and will fit only one way.

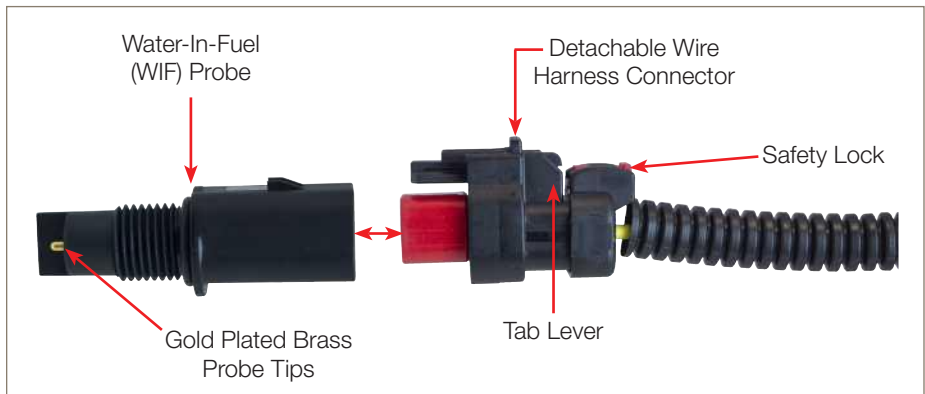

Specifications	RK 55484	RK56235	RK33801	RK33802	RK33803	RK55725	RK55726	RK56236	RK56237
Mating Connector	Delphi Packard 12162000	Delphi Packard 12162000	None	None	None	Deutsch DT042P-E003	Deutsch DT042P-E003	Delphi Packard 12052641	Delphi Packard 12052641
Thread Size	1/2"-20 UNF								
Volts	12 or 24	12 or 24	12 or 24	12 or 24	12 or 24	12 or 24	12 or 24	12 or 24	12 or 24
Probe Tips	Gold Plated Brass	Gold Plated Brass	Gold Plated Brass	Gold Plated Brass	Gold Plated Brass	Gold Plated Brass	Gold Plated Brass	Gold Plated Brass	Gold Plated Brass
Wire Length (L)	8.0 in. (20.3 cm)	4.0 in. (10.2 cm)	6.0 in. (15.2 cm)	8.0 in (20.3 cm)	8.7 in (22.1 cm)	6.0 in (15.2 cm)	12.0 in (30.5 cm)	14.0 in (35.6 cm)	5.0 in (12.7 cm)
Internal Resistor	220K ohm	220K ohm	82.5K ohm	None	None	82.5K ohm	82.5K ohm	220K ohm	220K ohm
Application	Cummins	-	Cummins	All	All	Cummins	Onan	Bluebird	Daimler

All Racor 2-wire WIFs must be connected to an additional component called a water detection amplifier.

Vacuum/Compound Gauge Kits

Vacuum and Compound (vacuum/pressure) gauges and related hardware are available to monitor filter condition. As the filter slowly becomes clogged with contaminants the restriction (resistance to flow) increases. The fuel pump still tries to draw fuel (suction) but because of this restriction less fuel is delivered to the engine and instead more air is pulled from it (fuel degassing). These results can cause the engine to lose power and eventually stall.

By installing a vacuum gauge in your fuel system (on the outlet side of the Racor filter) visual monitoring of filter condition is possible at a glance. Note the position of the dial, or apply the 'red line' decal provided with most kits. This will assist in easy monitoring as filter efficiency begins to decrease when a filter change is necessary.

Note: Intervals of filter changeout may vary depending on fuel cleanliness. Always keep a spare Racor filter on hand.



PFHG15LF
30/60 PSI Gauge

Accessories

Enhance Your Fuel Systems Performance and Ease of Service

When is My Engine Fuel Filter “Used Up?”

Because it performs so well, it is not uncommon for the engine fuel filter to appear as if it has reached its capacity. The only way to know when the engine fuel filter has reached its capacity is to measure the restriction at service.

An effective way to verify restriction is with a fuel filter restriction indicator. A restriction indicator will provide a quick and accurate assessment of the fuel filter's condition and remaining service life.



Vacuum restriction indicators monitor element condition as the filter slowly becomes clogged with contaminants. As the element gets dirty, restriction increases and less fuel is delivered to your engine causing the engine to lose power and eventually stall. By installing a vacuum indicator in your fuel system, visual monitoring of element condition is possible at a glance, increasing fuel system troubleshooting efficiency, eliminating guess work, and lengthening element change intervals.

Part Number	Thread Size
RK 32036	3/8" SAE Threads
RK32037	1/8" NPT Threads









Part No.	Description	Tread Size	
RK 11233	Vacuum Gauge, Silicone Dampened, 2" dial, 0-30 inHg. (0-15 PSI)	1/4" NPT Back Mount With Bracket	
1606B	Vacuum Gauge Kit. Gauge (RK 11233), one 7232-4, And One 7234-4 Fitting	1/4" NPT Back Mount With Bracket	
7232-4	Adapter Fitting	1/8" MNPT x #4 (1/4") Hose	
0102-4-2	Adapter Fitting	1/4" NPTM x 1/8" NPTF	
RK11-1676E	Vacuum Gauge With 2" Dial, Rotating Bezel, And Red Tell-Tale Pointer. 0-30 inHg. (0-15 PSI)	1/4" NPT Bottom Mount	
RK11-1969	T-Handle Vacuum Gauge (for 500FG Turbine series fuel filter/water separators)	1/4" NPT x 3/4" Fitting Threads	
RK 11-1669	T-handle Vacuum Gauge (for 900 and 1000 Turbine series fuel filter/water separators)	1/4" NPT x 1" Fitting Threads	
RK 19492	UL-Listed Brass Drain Valve	1/4" NPTF	

Water Detection Modules & Kits

Racor Water Detection Kits are available in a wide selection for various installation requirements. Under-dash, in-dash, and remote mount, these solid-state units may be used with any Racor fuel filter/water separator and water probe. They are manufactured using the highest quality materials and

are all 100% electrically tested. An electronic detection module analyzes electrical resistance at the water probe and determines if water is present. If so, the detection module operates to indicate water, based on its features listed below. All units reset automatically after water is removed (unless specified).

Caution: The water probe and detection modules work with 12 or 24 volts, direct current only and should never be wired to other brand modules or household 110 or 220 volts, alternating current. Use the guide below to find the correct detection module for your application.

Part Number	Description	Voltage	Image
RK 12870	Under-dash water detection module. Light illuminates and alarm sounds when water is detected. Water must be drained to reset light and stop alarm. Plastic enclosure measures: 1.38" square x 1.25" deep. Water probe included.	12 vdc	
RK 12871	Same as above	24 vdc	
RK 20725	Under-dash mount water detection module. Light only. Green 'ON' lamp illuminates with power on. Red 'DRAIN' lamp illuminates when water is detected. Initial power-up self diagnosis feature and circuit protection included. Plastic enclosure measures: 2.75" x 1" x 1.5". Water probe included.	12 vdc	
RK 20725-24	Same as above	24 vdc	
RK 20726	2" gauge-type water detection module. Light and audio. Red 'DRAIN' lamp illuminates and horn sounds when water is detected. Initial power-up self diagnosis feature and circuit protection included. Plastic case, satin black dial with white lettering. Water probe included.	12 or 24 vdc	
RK 11-1570 ¹	2" gauge-type water detector and filter restriction module. Includes pre-set vacuum switch (7 inHg), connector, and outlet adapter fitting. Red 'DRAIN' or 'CHANGE FILTER' lamp illuminate and horn sounds when water is detected. Water probe included.	12 or 24 vdc	
RK 14329	Remote detection unit sends 12 VDC hot (+) signal when an input ground signal (from a water probe or a vacuum switch—not included) is received. Must be used with a relay to power a horn or indicator lamp (if draw is over 1 amp). Plastic enclosure measures: 3" x 2.5" x .75"	12 vdc	
RK 14321	Same as above	24 vdc	
14332	Under-dash mounts same as RK 14329 but sends a ground (-) signal. Enclosure size is same as RK 20725 above.	12 vdc	
RK 20163	Vacuum Switch Kit Non-adjustable, 'Normally Open' contacts close at 7 inHg (3.4 PSI) 1/8"-27 NPT threads. For use with all models.	N/A	
RK 21030	Vacuum Switch Connector Kit Molded connector with single 18 AWG., 18" blue wire lead.	N/A	
RK30880E	This kit includes new and enhanced detection electronics built into the probe body and works with 12 or 24 volt DC systems. Water probe and detection module all in one.	12 or 24 vdc	

¹ Clear collection bowl must have a 7/8" SAE port.

Primary (Pre-) Fuel/Water Separator For Vacuum Applications And Final Fuel For Pressure Applications

Fuel is drawn out of the fuel reservoir by the lift pump into and out of the pre-fuel filter/water separator. The fuel is pre-filtered through a 10 to 30 micron rated filter which also removes harmful water, thereby protecting the lift pump and injection system. The lift pump pressurizes the pre-filtered fuel into the final filter. Fuel is then filtered by a 1 to 7 micron rated filter, ensuring purified fuel is delivered. The combination filtration system design provides superior protection for heavy-duty applications where high levels of contamination and high volumes of fuel require a high filter capacity. Fuel conditioning options (drain, water sensor, hand primer pump, heater, etc.) are usually installed in the primary assembly. Racor's P-Series (page 9) integrates the primary pre-filter and a lift pump into one package.

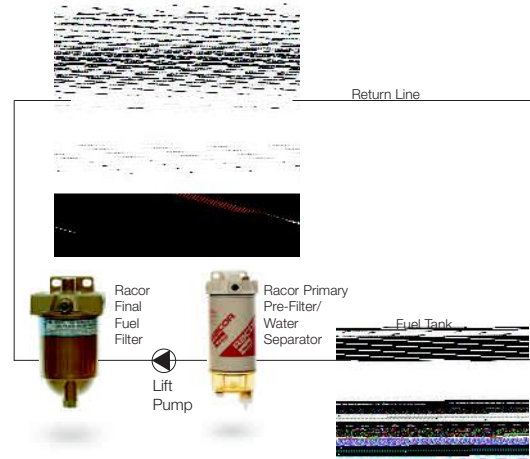

Secondary (Final) Fuel Filter/Water Separators For Vacuum Applications

This design integrates the primary fuel filter/water separator and final fuel filter into one system that is installed prior to the lift pump. The single assembly provides total filtration (4 to 7 microns) and water separation for the entire fuel system. This filtration system design provides excellent protection for applications where cost and service constraints are a challenge. Sufficient space for an adequate size combination unit must be available.

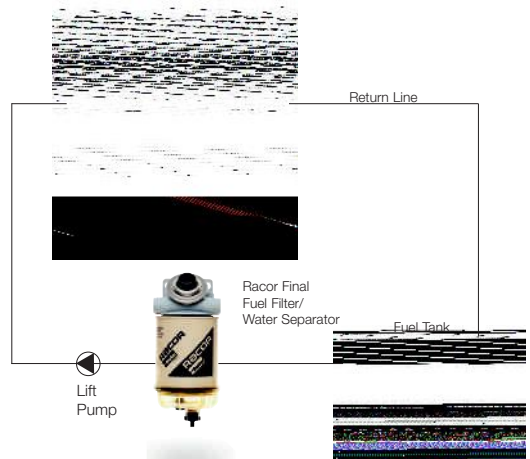

Secondary (Final) Fuel Filter/Water Separators For Pressure Applications

This design integrates the primary fuel filter/water separator and final fuel filter into one compact system that is installed after the lift pump. Generally, an in-fuel reservoir filter screen (100 to 200 micron) is utilized to complete the filtration system. The final fuel filter/water separator is installed after the lift pump and provides protection (4 to 7 microns) to the high pressure injection system. This filtration system design provides economical fuel injection system protection for small diesel engines, automotive and light-truck applications that already have generally good fuel quality and a relatively low volume of fuel usage.

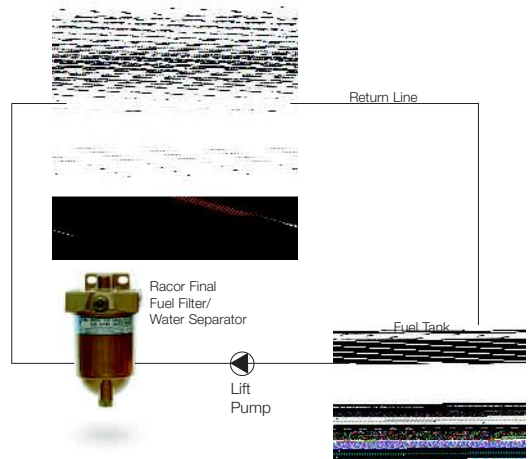

Typical Filter/Separator Options



245R



460R



110A



120AT

Heavy-Duty Air Cleaners & Replacement Elements

Racor has expanded its air filtration family of products to include Heavy-Duty Air Cleaners and replacement air filter elements (formerly Farr Transportation Products Group). These high-capacity, efficient and flexible products expand the breadth of line that Racor customers have grown to expect.

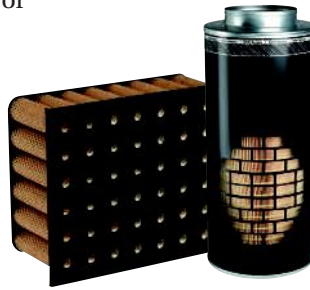

Brochure number #7539.

Heavy-Duty Combination Air Filters & Pre-Cleaners

Racor Combination Air Filters and Pre-Cleaners are designed to be connected to the air intake or to replace the existing standard air cleaner on diesel and gasoline engines. There is a wide range of centrifugal pre-cleaners and combination air filter/centrifugal pre-cleaners for agricultural machinery; earth-moving equipment; stationary engines; generator sets; trucks, buses and recreational vehicles; material handling equipment; snow removal equipment; and street sweepers.

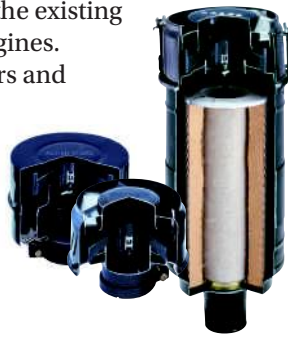

Brochure numbers #7539.

Air Filter/Silencers & Crankcase Ventilation Filtration Systems

Racor Air Filter/Silencers and Crankcase Ventilation Filtration Systems help to keep marine engines and engine rooms contaminant and vapor free. The patented CCV™ contains Racor's high-performance Vaporbloc™ filter made with depth-loading, engineered fiber-coalescing media. The marine air filter/silencer contains a washable media and is designed to connect easily to the Racor CCV to complete the system.



AFM

CCV™

Brochure numbers #7790 and 7501.

Marine Air Replacement Filters

Racor now offers replacement filters for marine applications. These filters are direct replacements for the intake air filter portion of various brands of air filters/silencers.



Brochure number #7501.



ParFit™ Hydraulic Elements

The competitively priced ParFit™ hydraulic elements are interchangeable with OEM and aftermarket elements to allow users to acquire all their replacement elements from one quality source.

Brochure number #7729.

Bypass Oil Filtration Systems

Removes dirt, varnish, ash, tar, soot and other contaminants along with condensed water which forms damaging acids if left in the oil.



Bypass Oil Absolute Series

Brochure number #7815.

Parker Racor Division Quality Management System Certifications

- **ISO/TS 16949: 2002**
- **ISO 14001: 2004**

Fuel Filtration

Racor Division wrote the book on fuel filtration technology. Please call us at 1-800-344-3286. Ask for technical service to request part number #7550.

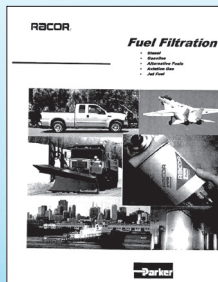

Parker's Product Information Center

Parker Hannifin has become a world leader in motion and control technology by providing premier customer service. That's what our Product Information Center is all about. Our experienced agents are ready to provide you with the product identification and referral service you need. Emergency breakdown calls are relayed via pager to agents on call who will respond promptly. Non-emergency calls are recorded and answered the next business day.

Tap Into the Knowledge Network

Every agent has access to extensive computer databases referenced by part number and product category. Information encompassing 200 worldwide facilities, 400 product lines, and 1,200 market segments is at their fingertips. Our goal is to make it as easy as possible for you to do business with Parker.

Language Line Service

By using the Language Line Service, we can access interpreters for more than 140 languages immediately. Handling non-English-speaking inquiries is not a problem!

Product Information Center

U.S., Canada, Mexico call: 1-800-C-Parker (1-800-272-7537)
 Fax: (440) 266-7400
 E-mail: c-parker@parker.com
 Hours: Monday - Friday 8:00 a.m. to 6:30 p.m. EST
 Saturday 7:00 a.m. to 12:00 p.m. EST

For Service within Europe:

From AU, CH, DE, EI, FR, and UK, call: 00800 27 27 5374

All other countries, call:
 English speaking service +44 1442 358 429
 German speaking service +44 1442 358 428
 French speaking service +44 1442 358 427
 Fax: +44 1442 458112
 E-mail: epic@parker.com
 Hours: Monday - Friday 08:30 to 18:00 CET

Parker Filtration's Products and Systems



AEROSPACE

Key Products

- Filter Vessels (API/IP)
- Fluid Conditioning Monitors (Fuel & Hydraulic)
- Fuel Filter/Water Separators
- Fuel Inerting Systems (OBIGGS)
- Fuel Loading Filters (API/IP)
- Fuel, Hydraulic, & Lubrication Filters
- Nitrogen Tire Inflation Systems



FOOD & BEVERAGE

Key Products

- Carbon Dioxide Purifiers
- Compressed Air Dryers
- Fiber & Membrane Filters
- Nitrogen Generators
- Stainless Steel Filter Housings
- Steam & Sterile Air Filters
- Validation Test Equipment
- Water Chillers
- Water Filters



INDUSTRIAL & PLANT EQUIPMENT

Key Products

- ASME Coded Vessels
- Compressed Air Filters
- Condensate Management
- Contamination Monitoring
- Desiccant Dryers
- Membrane Filters & Dryers
- Refrigerated Dryers
- Hydraulic Filters
- Oil/Water Separators
- Process Filters
- Portable Hydraulic Systems



LIFE SCIENCES

Key Products

- Breathing Air Filters & Systems
- Chillers
- Compressed Air Filters
- Filter Integrity Analyzers
- Gas Sterilization Filters
- High Purity Gas Filters
- Hydrogen Gas Generators
- Nitrogen TriGas Systems
- Sterile Water Filters
- Syringe Filters



MARINE

Key Products

- Air Intake Filters
- ASME High Flow Vessels
- Crankcase Emission Filter Systems
- Fuel Dispensing Filters
- Engine Fuel Filter/Water Separators
- Engine Oil & Coolant Filters
- Gasoline Filters
- Hydraulic Filters
- Hydrocarbon Fluid Filters
- Oil/Water Separators
- Submarine CO₂ Reduction Units
- Water Desalination & Purification Systems



OIL & GAS

Key Products

- Air Intake Filters
- ASME High Flow Vessels
- Compressed Air Filters & Dryers
- Compressed Air Water Separators
- Crankcase Emission Filter Systems
- Engine Fuel Filter/Water Separators
- Engine Oil & Coolant Filters
- Fluid Condition Monitoring Systems
- Fuel Dispensing Filters
- Hydraulic Filters
- Hydrocarbon Fluid Filters
- Integrity Test Equipment
- Nitrogen Generators
- Mechanical Separators
- Membrane & Sterile Air Filters
- Oil/Water Separators



POWER GENERATION

Key Products

- Air Intake Filters
- ASME High Flow Vessels
- Bioenergy Water Chillers
- Crankcase Emission Filter Systems
- Engine Fuel Filter/Water Separators
- Fluid Condition Monitoring Systems
- Fuel Dispensing Filters
- Load Tap Filters
- Hydrogen Generators
- Magnetic Prefilters
- Nitrogen Generators
- Portable Hydraulic Systems
- Water Sensors

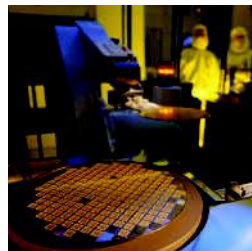

PROCESS

Key Products

- Alternative Gas Dryers & Absorbers
- Bag Filters
- Compressed Air Dryers
- Instrumentation Filters
- Nitrogen Generators
- Oil Absorption Filters
- Pleated Filter Cartridges
- Process Filters
- Semiconductor Filter Cartridges
- Stainless Steel Prefiltration Vessels
- Zero Air Generators



TRANSPORTATION & MOBILE EQUIPMENT

Key Products

- Air Intake Filters
- Alternative Fuel Filters
- ASME High Flow Vessels
- Crankcase Emission Systems
- Fuel Delivery Systems
- Fuel Dispensing Filters
- Fuel Filter/Water Separators
- Multi-stage Filter Systems
- High Pressure Natural Gas Filters
- Nitrogen Tire Inflation Systems
- Suction & Return Line Hydraulic Filters
- Transmission Filters
- Truck & Railway Dryers



WATER

Key Products

- Desalination & Purification Systems
- Oil Absorption Filters
- Oil/Water Separators
- Pleated Filter Cartridges
- Stainless Steel Prefiltration Vessels
- Sterile Water Filters



ENGINEERING YOUR SUCCESS.

Worldwide Filtration Manufacturing Locations

North America

**Compressed Air Treatment
Filtration & Separation/Balston**
Haverhill, MA
978 858 0505
www.parker.com/balston

Filtration & Separation/Finite
Oxford, MI
248 628 6400
www.parker.com/finitefilter

**Purification, Dehydration &
Filtration Division**
Lancaster, NY
716 685 4040
www.parker.com/pdf

Sales Office
Charlotte, NC
704 921 9303
www.parker.com/pdf

**Engine Filtration &
Water Purification**
Racor
Modesto, CA
209 521 7860
www.parker.com/racor

Racor
Holly Springs, MS
662 252 2656
www.parker.com/racor

Racor
Beaufort, SC
843 846 3200
www.parker.com/racor

Racor – Village Marine Tec.
Gardena, CA
310 516 9911
desalination.parker.com

Hydraulic Filtration
Hydraulic Filter
Metamora, OH
419 644 4311
www.parker.com/hydraulicfilter

Process Filtration
Process Advanced Filtration
Oxnard, CA
805 604 3400
www.parker.com/processfiltration

Europe

Compressed Air Treatment
domnick hunter Industrial
England NE
+44 (0) 191 402 9000,
www.domnickhunter.com

Hiross Zander
Padova Business Unit
Angelo di Piove Padova, Italy
+39 049 9712 111
www.parker.com/hzd

Hiross Zander
Essen Business Unit
Essen, Germany
T +49 2054 9340, F +49 2054 934164
www.parker.com/hzd

Parker Gas Separations
Etten- Leur, Netherlands
+31 76 508 5300

**Engine Filtration &
Water Purification**
Racor
England
+44 (0) 1924 487000,
www.parker.com/rfde

Racor Research & Development
Stuttgart Germany
+49 (0)711 7071 290-0
www.parker.com/racor

Hydraulic Filtration
Hydraulic Filter
Arnhem, Holland
+31 26 3760376
www.parker.com/eurofilt

Urjala Operation
Urjala as Finland
+358 20 753 2500
www.parker.com/fi

Condition Monitoring Center
Norfolk IP 24 1HP England
+44 1842 763299
www.parker.com/cmc

Process Filtration
domnick hunter Process
DH3 2SF England
T +44 (0) 191 410 5121
www.domnickhunter.com

Asia Pacific

Australia
NSW 2154, Australia
+61 2 9634 777
www.parker.com/australia

China
Shanghai 101206 China
+86 21 5031 2525
www.parker.com/china

India
Mahape, Navi Mumbai 400 709 India
T +91 22 5613 7081, 82, 83, 84, 85
www.parker.com/india

Japan
Yokohama-shi, 244-0003 Japan
T +81 45 870 1522
www.parker.com/japan

Korea
Hwaseong-City Gyeonggi-Do, Korea
T +82 31 359 0771
www.parker.com/korea

Singapore
Singapore 619 702
T +65 6887 6300
www.parker.com/singapore

Thailand
Bangkok 10250 Thailand
T +66 (0)2 186 7024
www.parker.com/thailand

Latin America
**Parker Comercio Ltda.
Filtration Division**
Sao Jose dos Campos
CEP 12225-390 SP Brazil
+55 12 4009 3500
www.parker.com/br

Pan American Division - Miami
Miami, FL
305 470 8800
www.parker.com/panam

Africa
Aeroporto Kempton Park,
1620 South Africa
+27 11 9610700
www.parker.com/eu